

# XICOY®

INNOVATION & TECHNOLOGY

BY GASPAR



## Xicoy TurboJet Engines

### User Manual

Version 1.5/2024

Congratulations on your purchase of a new generation Xicoy "X" Series gas turbine engine. We are confident you will be pleased with your purchase and your new engine will give you excellent service and maximum enjoyment to your hobby.

"X" series engines are the result of a very extensive research and development programme by Xicoy Electronica SL supported by the latest fluid dynamics and analysis software to bring you engines of unparalleled performance and incredible response in an amazingly small package. New electronics design and digital programming sets a new high bar standard for this new generation of small jet engines.

*Features:*

- *Massive thrust in tiny industry beating case sizes*
- *Low thrust*
- *Low installed weight*
- *Valves installed on-engine*
- *ECU mounted on engine*
- *Internal kero burner and thermocouple for clean exterior*
- *Fast spool up to max rpm*
- *Super-fast auto-restart with normal and glider modes*
- *Automatic cooldown after run with receiver power turned off*
- *Automatic power-off after cooldown*
- *Brushless high speed starter*
- *Intelligent brushless fuel pump*
- *High speed digital control of all components*
- *Neat slip-on FOD screen included as standard*
- *Choice of display options, on and off board.*
- *Telemetry options available for most modern transmitters*
- *2<sup>nd</sup> install kits available to swap engine between two airframes*

*New options are being added from time to time,  
Keep watching on: [www.xicoyturbines.com](http://www.xicoyturbines.com) for details*



If you sell or pass on this engine to a 2<sup>nd</sup> or subsequent owner please also pass on this User's Manual or its link, so they can enjoy a safe and fulfilling ownership too.

The Xicoy Electronica SL responsibility is limited exclusively to the repair of the engine and accessories which are outlined in the conditions of warranty.

Before unpacking the engine, please read through these notes and agree to the conditions of warranty.

Customer satisfaction is important to Xicoy Electronica. Technical support is readily available through your local dealer and via email:

Xicoy Electrónica SL, Plaça Pere Llauger Nau 18, 08360, Canet de Mar, Barcelona, Spain

Web site: [www.xicoy.com](http://www.xicoy.com) Email: [sales@xicoy.com](mailto:sales@xicoy.com)

See our new turbine webpage at: [www.xicoyturbines.com](http://www.xicoyturbines.com)

Here is a contents list for this manual. Use ctrl-click to fast access any section.

Legal and Disclaimer .....	5
Disclaimer.....	5
Warranty .....	5
.....	6
Safety Notes .....	7
General Notes.....	8
Engine Specifications.....	10
Package Contents .....	11
ECU Battery .....	11
Battery consumption .....	11
Auto battery disconnect.....	11
Fuel .....	12
Engine Description.....	13
Component Description .....	16
ECU (Engine Control Unit).....	16
Menu Items.....	16
Battery recognition .....	16
Kero/Diesel Selector .....	17
Max thrust pre-set .....	17
Pump pre-set.....	17
Extended run recording .....	17
Hub .....	17

Auto Power-Off.....	18
Hub installed ambient sensors.....	18
Fuel Pump.....	19
Construction.....	19
Pre-setting.....	20
ECU Display .....	21
ECU data record / playback .....	21
Plug-in backlit display.....	22
Navigating Menu Screens .....	23
Engine Installation: Electrical connections .....	28
Shared ECU battery .....	28
Radio Setup .....	29
Aligning transmitter with ECU.....	30
Failsafe .....	31
Preparing the engine for running.....	31
During start-up - general.....	32
First engine run.....	32
Starting the engine.....	33
1 <sup>st</sup> Run? .....	33
Adjusting the engine maximum power. ....	34
Engine shut down procedure .....	34
Autorestart function .....	34
Restart Disclaimer.....	37
Throttle curves .....	37
Throttle stick position chart .....	37
Acceleration and deceleration settings.....	37
Diagnoses: .....	39
Diagnosis messages: .....	40
Telemetry:.....	40

## Legal and Disclaimer

The engine design and contents of this User Manual are copyright Xicoy Electronica SL, Canet de Mar, Barcelona, Spain. All rights are reserved.

This User manual, pictures and data are the property of Xicoy Electronica SL and cannot be used or reproduced in any way with written permission from Xicoy Electronica SL.

## Disclaimer

This "X" Series engine is a very sophisticated piece of machinery. Great care should be taken at all times when using the engine. It should only be operated by those with appropriate skills and knowledge to do so. The engine is not a toy. Incorrect operation or misuse can cause damage to property and bodily harm to operators, spectators or animals. Xicoy Electronica SL accepts no liability any damage which may occur.

Xicoy Electronica SL assumes no responsibility for any errors contained in this document and is not liable for any damages resulting from such errors.

***It is forbidden to use this engine outside radio control applications, especially those that power vehicles to carry people.***

## Warranty

- The warranty duration for this engine is two years from date of completed purchase, or 25 running hours, whichever comes first.
- Warranty is valid solely for the original 1<sup>st</sup> owner and is non-transferable upon resale.
- Warranty included all supplied parts and is limited to manufacturing defects only.
- Shipment costs forth and back, including packing and relevant customs fees **are not covered** by the warranty, and will be at owner's expense.

Damage or defective operation covered under warranty terms will be repaired and tested at no cost to original owner (other than shipping expenses). Repairs not covered under the terms of warranty will be carried out by Xicoy Electronica SL or their appointed agent after agreement of costs.

**Before** returning the engine or ancillary equipment for service or repair, please contact first your local dealer or Xicoy Electronica SL central office to agree action and costs.

**Do not ship before contacting Xicoy Electronica first. Shipping anything from outside the EU without appropriate documentation will introduce significant delay and costs at customs borders.**

*Please do not disassemble this engine or accessories (pump etc). You will breach your warranty agreement and will find it an unfamiliar sophisticated and precision assembly which you may not be able to reassemble without considerable difficulty and specialist equipment.*

*Simply slackening the compressor nut on the engine will lose the delicate balance condition of rotor without which the engine may not run without sustaining damage to the rotating assembly.*

This warranty is voided if any one or more of the following conditions applies. In such a case Xicoy Electronica SL will accept no responsibility for any damage or other consequence caused by engine operation.

1. The product has been subject to any form of operation using incorrect fuel, oil or fuel/oil mix.
2. The product is, or appears to be crash damaged, the fuel pump is blocked due to particle ingestion, electronics or pump-drive are flooded with fuel or water ingress, connection leads are cut or show loss of insulation and/or short circuit or reverse polarity on battery or engine cable connection.
3. Unauthorized maintenance and/or modifications have been made to any part of the product; including unlocking of the ECU and changing any of the manufacturers settings, or any items supplied has or appears to have been disassembled.
4. Parts show damage by ingestion of foreign object (wires or pipes, sand, grit and small abrasive particles, water or fluids, dry powder from extinguisher).
5. The engine has or appears to have been operated incorrectly or not in accordance to this operators manual.
6. The product has been or appears to have been misused, neglected or inadequately maintained.
7. The engine or fuel pump has or appears to have suffered damage or blockages in the fuel system due to being run with unfiltered or contaminated fuel.
8. The engine and/or accessories show damage by physical contact with a corrosive substance through operation or storage.



## Safety Notes

Please remember that though this engine is small it is most definitely NOT a toy and has the potential to hurt you or others around you if misused. The engine is a very high performance machine in miniature and must always be treated with a high level of care and safety when in your operation. It is your responsibility as owner, to ensure safe and considerate operation at all times and conforming to the word and spirit of this User Manual. By running this engine you agree to assume full responsibility for its safe operation.

The following guidelines should be read carefully and followed:

- Always keep a CO2 or similar gaseous fire extinguisher of at least 2kg contents close to hand when starting and operating the engine. Do not use a powder extinguisher unless of last resort as the powder will ruin the engine if it used.
- Protect eyes and ears during the starting procedure.
- Be especially aware this engine is very fast to start, initiate only when ready.
- Please note this engine is extremely fast to spool to maximum thrust, use the throttle control carefully, especially with very small models.
- Be aware of the extreme intake suction, use the available and supplied food filter screen always.
- Always run the engine in open air as engine exhaust contains gases which can cause asphyxiation and nuisance smells.
- The engine WILL be very hot while running, so please don't touch it.
- Keep clear anything affected by heat away from the engine, especially the exhaust area.
- Don't run the engine anywhere near a source of flammable gases, liquids or materials.
- Don't run the engine or fly the plane in wooded or crop or other high fire risk areas.
- Keep spectators, children and animals clear of starting area (10mtrs (30ft) radius away).
- Always handle turbine fuel and oil with care as they are flammable and can cause a reaction with sensitive skin. Store them in clearly marked containers and always dispose appropriately. Use protective gloves when mixing and decanting fuel and oils. Avoid all skin, eye, mouth or ingestion contact with the liquids and ensure any spillage is wiped up immediately. Clean any affected area with warm soapy water. Wash hands and any affected part immediately after any contact.
- Continued excess priming or failing of the starter burner can result in pooling of fuel inside the engine which could cause excess flaming in event of subsequent ignition. The only method to clear the engine is to tip it forward and allow excess to escape through the front of the engine. Mop up with a rag. Tipping it backwards will not work as the internal construction of the engine prevents any liquid draining out to the rear.

## General Notes

This engine is a real gas turbine machine with very high rotational speeds and high temperature fast moving exhaust. Despite the small intake the engine is able to swallow a huge amount of air and anything else that air can carry with it. So before running please carefully check the area surrounding the front and back end of the engine for any loose materials like rags, sawdust, sand or grit, modelling materials, liquids, or anything else that can be picked up by the airstream and sucked into the engine, or blown out at speed by the exhaust.

If you are new to turbines or returning after some years it is a good idea to set up the engine on a simple test stand so you can get familiar with its operation before installing it into a model. Use a maximum thrust setting that is appropriate for your model especially on 1<sup>st</sup> flights. The RUN menu shows this clearly, see "*derating*". A power/weight ratio of 1:1 sounds great but can accelerate a model dangerously quickly and can lead to control or structural failure of the model. If you have recent jet engine experience you should be able to install the engine straight into your model but take careful note of the quick response in start-up and throttling. Every engine is carefully test run at the factory to ensure it performs properly, so you can take confidence to know it is fully operational at time of despatch.

Being an internal combustion engine the engine will consume oxygen during running so must never be run inside or in a confined space. The engine consumes a volume of air about 20ltrs/.74cu.ft FOR EVERY KG OF THRUST every SECOND (ie, 4.5kg = a dustbin full) so can quickly use up a lot of air in a limited space, so only run outside in open air. Never try to slow the engine by placing any kind of restriction on the intake or the exhaust or on the model. The suction is more powerful than any vacuum cleaner and can do severe damage to anything passing into the intake. It can also collapse an airframe where insufficient area for the intake air is provided, or is restricted in some way. The fod screen supplied is intended to prevent small articles being drawn into the engine like blades of grass, small stones etc. It cannot prevent a rag or similar being accidentally jammed against the front of the engine by the suction, so please take great care. Never test the suction with fingers or hand, these engines bite hard.

The engine exhaust exit is small but with such a large volume of gas passing through it at pressure it makes a loud penetrating noise. At a distance this noise is most pleasing but in close proximity (within 5mtrs/16ft) the noise level can be very hazardous to hearing so always ensure you and any nearby helpers have proper ear defenders and are wearing them while test running the engine. Ensure you check carefully the area where you plan to run the engine and have someone keep lookout for inquisitive bystanders who could approach to see the source of the noise, as you will be concentrating on the engine. Agree a system of hand signals in advance so they know what you are planning to do and can warn you of any issue during the run, i.e. shut down in a hurry or reduce to idle if someone (or an animal) is approaching, walking by, etc.

The engine has its own internal starting system and does not require any assistance or priming to operate. So please do not try to assist it to start quicker or easier by administering any flammable agents, sprays or similar, into the engine in the belief it will start better. It won't, but it could result in causing a dangerous flashback or fire to start which could rapidly get out of control and putting yourself in danger or more surely the destruction of your model. The engine **does not**



need priming like a petrol or glow engine to start, so when filling the fuel line for the first time leave a couple of cm of empty pipe where it connects to the engine to be sure you have not pushed a puddle of fuel into the engine which can cause a flame on start-up.

The engine is happiest operating with the cable connector upwards and the fuel inlet below. But if it suits your installation better the engine can function safely rotated to suit your installation, but you will find starting is quickest and easiest with the recommended positioning. If you find the engine cable length is not sufficient for your installation, please do not cut it and try to extend it, please get in touch with the Xicoy office for a longer version.

The engine has a replaceable internal starting glow plug. This is an Authorised Dealer and/or Service Agent replaceable component as the engine must be opened to access it.

Note- unauthorised opening of the engine will void the warranty. The burner has been designed that the rotor is not disturbed during this process so the balance is retained. The engine also features an internal thermocouple. This avoids the danger to this delicate component being outside the engine from the usual knocks and bumps associated with engine install and refit. If the thermocouple needs attention please refer to nearest Service Agent or direct to Xicoy Electronica SL as the engine case requires opening to access it.

The engine starter is a high quality high speed brushless unit. The power driver for this is part of the ECU. It should go without saying you cannot replace this with anything else. You also cannot power the starter separately beyond using the "starter test" function. The starter is accessible and in the unlikely event of attention can be easily replaced. The small clutch fitted to the starter motor has a small O-ring which may wear in service. It is easily replaced if required.

Please note that the accessories used for this engine use the simple 3-wire servo type cable connection. This includes the fuel pump, display, sensors, telemetry adapters etc. In all cases the third wire (usually orange or white) is a digital signal line so DC power should not be applied to this line or attempts made to read the voltage on this line for fault-finding purposes.

Please refer to the Xicoy office for guidance in the first instance in event of any issue.



## Engine Specifications

	<b>X45</b>	<b>X60</b>	<b>X85/X90/X95</b>	<b>X120/X132</b>	<b>X160</b>	<b>X180/X195</b>	<b>X240</b>
Engine diameter	60mm	68mm	76mm	90mm	98mm	106mm	118mm
Length	160mm	159mm	183mm	198mm	210mm	247mm	270mm
Engine weight	398g	451g	706g	940g	1150g	1400g	1817g
Total installed weight	470g	526g	888g	1140g	1320g	1600g	1990g
Adjustable thrust range at sea level	25-45N	35-60N	45-85/90N/95N	60-120N/132N	75-160N	100-180N/195N	120-240N
Idle thrust	1.9N	2.8N	3.3N	4.3N	5.3N	4.8N	7N
Max rpm	225k	190k	176k	150k	140k	122k/124k	113k
Min. rpm	60k	55k	48k	40k	35k	30k	28k
EGT at max thrust	550 -700°C	550 -700°C	550 -700°C	550 -700°C	550 -700°C	550 -700 °C	550 -700 °C
Fuel consumption at max thrust	140g/min	200g/min	265/280g/min	350g/min /360g/min	430g/min	470g/min – 510g/min	600g/min
Minimum exhaust tube diameter	50mm	52mm	55mm	60mm	68mm	75mm	82mm
Battery recommended	Recommended 2S LiPo 3S LiFe can be used if 2s Lipo not possible.				Recommended 3s Lipo 3S LiFe can be used if Lipo not possible.		
Restart capable	manual (glider) & automatic						
Fuel / Oil	Kerosene + 4% oil mix.		Kerosene (recommended) or diesel + 4% oil mix.				

## **Package Contents**

Engine unit inc. fod screen

Fuel pump

Hub Lite + colour display + 300mm signal cable, OR / Compact Hub

Engine cable 450mm

Battery cable

Servo type cable 300mm x 1

Fuel filter

4mm tubing, 1mtr (also 0,6mtr of 6mm fuel tube, X120 -X180 only)

Instruction card USB

## **ECU Battery**

The engines have been designed to use a Lipo battery for power and all factory tests on all engines are performed using this type of battery.

3S LiFe batteries are allowed in the case that Lipo can't be used, but if possible use Lipo. Using a higher battery voltage than 12V will damage the ECU.

Use at least 25C batteries, there is no upper limit. Do not use other battery types like LiIon, these batteries cannot deliver the peak amperage (20-30A) necessary for starting.

## ***Battery consumption***

As example in mAh battery use, on average the X45 engine uses:

Start-up: 100mAh for X45

About 20mAh -30mAh for each minute running (depends on throttle position).

About 40mAh for cooling after a run.

A typical eight minute flight consisting of a start, normal flight and shutdown will consume:

$$100+(8 \times 20)+40 = 300\text{mAh}$$

For the X85/X90 these values should be approximately x1.2, for the X120 approximately x1.4 and for the X180, x 1.2.

Be sure to always disconnect the battery for charging. Some chargers use a high voltage pulse system which can destroy the ECU.

## ***Auto battery disconnect***

The receiver may be turned off as soon as the aircraft is retrieved from flight, the Hub unit will ensure the cooldown continues until the end. The Hub will then disconnect the battery after the end of the cooldown.

When the receiver is turned back on, the Hub unit will reconnect the battery. At the end of the flying day it is good practice to disconnect the ECU battery as safety measure because the ecu use a very small amount of current that can drain a 2000mAH battery in 1-2 month.

## Fuel

The engines can be run using Kerosene or Diesel fuel. Kerosene is the recommended fuel if available; it produces the best user experience as the engine starts and accelerates faster, without smoke, flames or unpleasant smell.

Diesel fuel is acceptable for most of the engines. The engine will not be damaged by using it, but user experience will be worse, the operation will generate more flames, smoke, slower start up and acceleration, odour, and can drip few drops of fuel out of the exhaust during startup. Power is the same using both fuels.

Recommended Kerosene fuel is the odourless refined Kerosene (some countries call it "Paraffin") used in home stoves, there are different commercial brands like "keroclair", "Ptx200", "Petroleum" as it is very clean and burns without smell. JetA1 will work the same but should be carefully filtered before use, but its odour can be offensive during model storage.

Use the fuel preset in the START menu to select your fuel: Kero / Diesel. The ECU automatically adjusts start settings for each fuel.

## Oil

The engine requires oil for lubricating bearings. This should be mixed at 4% with the fuel and all lubricating is then automatically metered and applied by the engine internal components.

If you use a 20ltr fuel bottle then add 0.8l of oil. For every 3 gallons of fuel add 1 pint of oil.

Recommended commercial oil is **Deluxe Power Model Jet Oil**. Other commercial turbine oils like Kingtech oil, Fuchs... can be used.

Don't use Jetcat oil, Jackadofsky oil or 2 stroke oil alone (4%). These cause a lot of bearing drag when cold causing difficult or impossible start-up.

If oil price is a concern, then it can be used a mix of 3% of ISO32 type of oil, (commercial brands like Mobil DTE Lite, Shell Tellus 32, Igol 32, Cepsa Turbine 32, etc) *plus 1% of 100% synthetic 2 stroke oil*. Plenty of commercial brands 2T oil are available locally, just check in the bottle that the oil is JASO FC or JASO FD compliant. **ISO32 or TCW3 type of oil alone is not approved**, always must be mixed with 2T oil.

It is allowed to use a 5% of oil contents for compatibility with other engine brands; this will cause a higher fuel consumption and increased possibility of internal carbon building. Use 4% if not using the recommended oil.

Full size turbine oils can be used, but are not recommended because these oils are not intended to be burned; they are irritant and contain neurotoxic chemicals such as tricresyl phosphate that in

long term could impact negatively on the health of operators and other persons breathing the exhaust fumes. Aeroshell 500 should not be used at all due to high residues left on bearings.

Please refer to the Xicoy Office for guidance in the first instance in event of any issue or concern.

## **Engine Description**

The X series engines are miniature turbojets designed and produced specifically to produce thrust to power small model aircraft. Each has a single stage billet machined centrifugal compressor and single stage cast Inconel axial flow turbine mounted on a single shaft. The engine is fitted with a long life ceramic glowplug which enables the engine to initiate combustion directly on liquid fuel after which further fuel is gradually introduced into the main part of the combustion chamber to provide combustion heat to operate the engine. A high speed brushless electric starter motor fitted with a clutch mechanism to the front provides drive to the rotor up to and beyond self-sustaining speed for starting the engine. The starting sequence is controlled by an electronic system fitted to the engine (ECU) which initiates the start sequence and controls the parameters of the engine within design limits.

The engine rotor shaft is supported by two ceramic bearings which are lubricated by a small percentage bleed off the pressurized main fuel supply, which should contain a small percentage of oil for this purpose. The rotor discs are separately balanced and then 2-stage dynamically balanced on assembly to the engine. Disturbing the rotor will lose this delicate balance and the engine will need to be returned to a service unit for rebalancing.

The fuel for the engine is provided from a fuel tank and fed through a small pump driven by a 3-phase (brushless) motor that has its own intelligent control. Each engine has its own dedicated pump type and may not be mixed.

The engine speed between idle and maximum is controlled by varying the speed of the fuel pump rotor by command from the electronic device called an ECU (Electronic Control Unit) that is mounted under the front cover of the engine. This sends commands to the fuel pump via a connector board (Hub) to turn at a certain rpm (and therefore flow rate) to deliver a precise amount of fuel and the fuel pump automatically adjusts itself to this rate. If the incorrect pump is fitted the ECU will identify this and will not proceed, but display an error message.

The communication between the ECU and fuel pump and all other function accessories, display, telemetry etc is via a single wire bidirectional digital data link, no analogue voltages are used and operation is not voltage sensitive.

To control the admission of fuel to the burner and main combustion chamber there are two miniature electric valves attached to a mounting block fitted to the front of the engine, under the cover. This block also holds a 4mm quick-release fuel feed connection. The valves are connected to and controlled by the ECU as required by the starting sequence. The valve block assembly is replaceable but the individual valve assemblies are not user serviceable.

## **Installation Notes**

1. The engine should be mounted securely using only the strap mount supplied.
2. The 3-wire connecting cable from the engine to the connector board should be carefully routed away from the engine intake so there is no possibility of the wire being accidentally ingested if the FOD screen should be displaced for any reason. Avoid placing the cable close to the engine rpm sensor which is located at approximately 4 O'clock when viewed at the front of the engine with the cable entry plug at 12 O'clock. A cable too close can cause some rpm interference at start-up. The same goes for any servo wires passing near.
3. The 4mm fuel feed pipe should be routed similarly clear of the intake.
4. The other end of the engine cable should plug into the Hub sited at a convenient location for access. This is also the location to connect the ECU battery. If battery is sited at some distance perhaps in the nose of the aircraft, please contact Xicoy and ask for a longer cable in one piece. Please don't cut it and splice in a couple of old bits of wire to make it longer. A heavy duty extension can be used but check polarity before plugging in. It's always better to have a longer single piece cable for minimum volt drop and maximum reliability.
5. The centre of the fuel tank should be located as close to the centre of gravity (CofG) of the model as possible. This will minimize the effects of the CofG shifting as the fuel is used during the flight. The fuel tank should have an effective fuel pickup, like a felt clunk or felt bag over a weighted clunk to ensure no air is pulled into the fuel feed.
6. The fuel pump should be located close to the fuel tank as convenient. Fit the inline filter between tank and pump to protect the pump from particles that could jam the pump. The pump has two screw fixings provided for mounting to the airframe.
7. If using "Tygon" flexible piping from fuel tank push on a short (12mm/1/2") length of the supplied 4mm pipe onto the pump suction port and push the "Tygon" over the top to provide a tight leak free fitting. A double wrap of lock-wire will ensure secure connection
8. ***DO NOT use nylon tie wraps anywhere on the fuel system.***
9. DO NOT use "Tygon" flexible piping anywhere for the pressure (delivery) side; it is only suitable on the suction side. Also **DO NOT** use silicon tube anywhere in the fuel system as the fuel will melt it.
10. Any air ducting to the engine inlet should have sufficient diameter of at least the engine case diameter.
11. If an extended exhaust duct (internal tailpipe) for internal installation is required, it should be diameter as shown in the Specifications, and stiff enough to resist flattening in the airflow. Leave a gap of 25mm (1") from tip of the exhaust to the end of the duct (excluding bell mouth length).

12. Extreme care should be taken to avoid the possibility of foreign objects, loose parts, dust or debris being allowed to enter the compartment where the engine is installed. Always use the supplied FOD screen but regard this as a last line of defence and not as a reason not to practice good housekeeping. Before filling the tank and starting the engine for the first time, turn the model upside down and give it a good shake to loosen and clear any small bits and pieces lying in the engine compartment. A go-around with the Hoover is also a good idea.
13. We recommend testing the engine on a test stand prior to fitting to an airframe.
14. You should have a clear idea how to arrange all the components needed to run the engine inside the model. The main issues are fuel tank (locate centre of tank to CofG), bubble trap position (if used), locating the fuel pump in close proximity to the source of the fuel (bubble trap or tank) and adjusting the receiver and ECU batteries to achieve optimum location for balancing the model.
15. *Do not* under any circumstances try to run the fuel pump by plugging it into any other FADEC brushless pump control or similar type 3-phase driver. It does not work like that and you will destroy it in the process.
16. If you have two models you want to use the engine for, purchase a 2<sup>nd</sup> Installation Kit and install all the components, pump, filter etc, as if it were a new install. You then only need to swap the engine over between the models and the remaining installation is not disturbed, which gives the greatest flight security. The engine can accommodate any slight changes due to the installation. Don't forget to blank off and cover the end of the fuel feed pipe to keep it clean.

## **Component Description**

### ***ECU (Engine Control Unit)***

The ECU and indeed the whole system used on these engines are totally new and unlike any previous version of Xicoy ECU. It is a new controller developed specifically for this application by Xicoy Electronica which is in the form of a small C-shaped pcb fitted under the front cover of the engine. It is connected via the 3-wire cable which plugs into the engine and to a small connector board called the "Hub" externally which forms the connection to the outside world. The three wires are just plus (+) minus (-) and data. The signals in and out of the ECU are via bidirectional digital data link, no direct connection is required, or possible.

The ECU is a powerful new design using a completely new architecture than used before, so represents not an upgraded version of anything before but a new system completely. This new platform allows us to break from the limitations of older technologies to make use of the latest high speed connectivity to add many more functions than were possible before, and all using a single wire data cable. All signals in and out of the ECU go via the Hub which acts as a clearing house for ECU data and the outside world.

The ECU is programmed specifically for each engine with the engine operating characteristics, start parameters, throttle curves and operating routines. Some of these are user settable like the radio setup and maximum thrust settings which are accessed used via a menu system on a special data display which plugs into the Hub or is part of the Hub itself. The ECU also controls the power to operate the two valves, the brushless starter motor and the glow plug. Two of the three wires in the 3-cable are the power for these.

### ***Menu Items***

Users familiar with other Xicoy ECUs will notice the menu structure is very similar to previous generation ECUs, but with some display items in new positions, some extra functions added and some removed. This is mainly because the ECU is specially produced for the "X" Series so functions which have previously been general purpose are now tuned specifically for the engine and fixed. Anything which could be preset or does not require adjusting has been removed from access to shorten the menus as much as possible to declutter.

Auto battery recognition

Kero / Diesel selector

Max thrust preset

Pump preset

Extended run storing

### ***Battery recognition***

Another addition is automatic detection and accommodation for LiPo and 9.9v 3-cell LiFe batteries. The ECU detects the battery voltage at plug in, and automatically adjusts all the parameters to work with the voltage supplied.



### ***Kero/Diesel Selector***

The kero/diesel option which switches between preset routines for each fuel. This saves you the ordeal of having to make many adjustments to fine tune the starting every time you switch fuels, now you just press a button to click your fuel, and go. Diesel being heavier and higher flashpoint fuel than kerosene requires a different start technique to enable it to start quickly and cleanly. We have spent time optimizing the engine for each fuel and have prepared two start routines. You choose the fuel option at the beginning of the START Menu and leave the ECU to use its pre-set start routine. We recommend increasing the idle RPM to get better acceleration when using diesel fuel.

### ***Max thrust pre-set***

To pre-set the engine to a reduced maximum rating there is a simple setting in the RUN menu which shows maximum rpm with a corresponding nominal thrust figure. So it is easy to dial in a certain thrust without having to know the rpm setting for this. This adjustment is operative between around half power and maximum. It can be adjusted while the engine is running.

### ***Pump pre-set***

A new engine package will have the fuel pump setting already set. In event of the pump needing replacement for any reason the user can set the new pump to the default setting (75) and see the heating effect on the engine on a start. If slow to heat up then the value can be raised to the next level (100) which should be sufficient. If the flow is too high, perhaps the pump is very strong, it may extinguish the ceramic element and make white smoke instead of proper ignition. In which case the value can be lowered to 75 and the test repeated. Settings beyond these are not needed.

Once set, this value can be left and does not need adjusting in normal use unless swapping the engine to a 2<sup>nd</sup> install. In this case it is a good idea to write on each pump the value used for the best starting and when swapping the engine over to enter this value in the START menu. In practice we have found no adjustment needed from the default setting. All other start functions are handled automatically by the ECU. There is no other fiddly tuning unlike in older kerostart systems.

### ***Extended run recording***

The heart of the ECU is one of the latest high speed microprocessors which enable it to carry out millions of instructions per second and do a great many things at the same time without having to stop and wait. It has its own memory so can hold programme instructions and operating data and store runtime data from previous engine runs.

### ***Hub***

To enable connection of the power supply and signals to and from the outside world to the ECU, a small connector board which we call the "Hub" is provided. This forms the connecting point for:

- The receiver throttle signal (max voltage 10v)
- ECU battery
- Fuel pump

- ECU on the engine
- Any display used, either on-board as part of the connector board, or separately plugged in
- Additional input sensors such as pitot pressure, rpm from a 2<sup>nd</sup> stage, etc.
- Additional output devices such as telemetry, SD memory storage, Bluetooth etc.

### ***Auto Power-Off***

The Hub has some intelligence of its own in that it can take a signal from the ECU and isolate (power down) the ECU battery after a cooldown has completed and the receiver turned off. The ECU will complete the cooldown process even if the receiver is turned off, it does not need a radio signal to do this.

This saves the battery in the transmitter and receiver and helps stop the possibility of leaving them on for long periods accidentally.

### **Hub installed ambient sensors**

Hubs also have installed a pair of ambient sensors for temperature and pressure. These sensors provide the ECU with data on ambient conditions which the ECU will use to pre-set certain function parameters to take account of. These include the acceleration and deceleration ramps and idle speed. In practice this means it is no longer needed for the User to provide any adjustment for day to day ambient conditions as these are now taken care of by the ECU.

Where an "Auto" option in any menu is offered, the ECU will use the Hub data to adjust the setting to the most appropriate for the conditions. To use this functionality the user simply leaves the pre-set in the RUN Menu to Auto.

### **Hub location**

Place the Hub unit in a location away from proximity with the exhaust or sunlight heating as otherwise its ambient sensors will tell the ECU it is a hot day and moderate settings appropriately.

The Hub is available in several options, all with the sensors built in:

The simplest being the "Lite" option which is just a plain shrink wrapped board to connect ECU battery, receiver, ECU, fuel pump and a full colour external display.

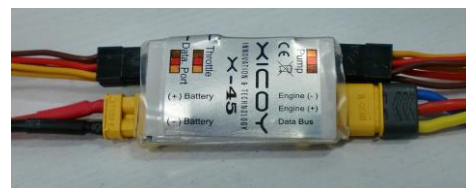

The other option is called "Compact Hub" which is housed in a small plastic box and has a black and white display and small adjuster buttons, which you can mount in your model to eliminate the need to plug in anything. The screen is very bright making it easy to observe the start-up on the display from a short distance through a canopy, for instance.



Telemetry connectivity is possible using a dedicated module. The Xicoy website, [www.xicoyturbines.com](http://www.xicoyturbines.com) will show what is available for the "X" Series engines at any time, new items are being added regularly.

Hubs have a printed panel showing where each cable goes and the orientation of each plug. For all cables, if you need a longer or shorter version than supplied, please contact Xicoy. Do not cut or splice in extra wire.

Battery should be connected directly to the Hub, not using switches, electronic regulators, diodes etc. Multiple battery operation using "Y" lead is possible but at least one battery must be directly connected. If you are using the full colour plug-in display this is also plugged in here.

## Fuel Pump

As mentioned previously, the fuel pump has been specially designed for this application and is unique in many ways. It is extremely small in size and weight but is much more sophisticated than its looks suggest. There is not the usual fixed cable with socket but a small plug built into the pump which enables a regular high quality JR type servo cable to be used as the pump cable (socket at both ends). This way it's easy to get just the right length you need without cutting or extending the wire.



Each engine has its dedicated fuel pump. When powering up the ECU will recognise it and if you try to use the wrong size pump you will get an error message and the engine will not allow a start.

## Construction

Inside the sturdy machined aluminium housing is a powerful, purpose made brushless (3-phase) motor with a ball raced (not plain bearing) shaft carrying a pair of precision close tolerance gears to provide the displacement pump function. A pair of nipples provides a secure connection for piping at inlet and outlet. Two tapped holes in the body provide a secure mounting location avoiding the need for tie-wraps and other messy fixings, for a neat and tidy installation. Never try to disassemble the pump, it has an extremely delicate internal structure and you will void its warranty. Each engine variant has its own pump, you cannot mix and match.

**Operation:** The difference between this pump and most others is that it also has its own tiny brushless 3-phase driver included within the pump housing. The motor is not a slave to an external driver or an open loop dc motor driven by an external voltage, but has its own sophisticated controller and driver built in. This controller communicates with the ECU via the Hub hundreds of times a second and this includes the identifier to ensure it is the correct pump for the engine. The ECU sends out a rpm request to the pump and receives actual rpm information and therefore flow rate return signals back, and this process is updated continuously at high speed.

*Please note, you must not try to run the pump by plugging this 3-wire cable into any brushless (3-phase) driver, the controller will be immediately destroyed.*

This system means the ECU does not have to spend time constantly controlling the pump speed, it only needs to send a brief signal to request a certain rpm. The on-board controller then looks after how this command is carried out and confirms it back when this is achieved. This enables the ECU to do other things like updating telemetry or collecting data from sensors, while still controlling the engine operation.

### ***Pre-setting***

The pump flow rate is set at the factory by setting the minimum rpm it produces sufficient heating from the burner for a start on the engine. This is the only required adjustment. Once set, the user needs make no adjustment to pump commands. We have made the increments 25 at a time as it was found unnecessary to use any greater precision to achieve the desired result in a very small range of numbers, usually 75, 100 or 125. Being based on a brushless motor it does not suffer from sticky seals or variable speeds due to atmospheric or fuel densities unlike regular DC motor based pumps. So the old juggle with adjustable "pump start point" is no more.

Applying a DC voltage to the fuel pump will not make it run so please do not try it. Modifying the cable and reverse connecting the polarity of the power supply wires will also **not** make it run but may destroy the internal pump controller, so don't risk ruining your pump by modifying your cable, just get the right length you need.

**Mounting:** The fuel pump mounts using two M3 tapped holes in the body. Orientation is not critical but is ideally mounted with the pipes uppermost to minimise the possibility of trapped air bubbles.

**Connection:** The pump direction of flow is marked with an engraved arrow from inlet to outlet. The fuel pump inlet should have the fuel filter installed closely inline to prevent any particles getting to the pump and jamming it. Use the piping supplied. The ring on the metal filter denotes the outlet to go to the pump. Do not run the engine without a filter. The X45, X85 and X90 use 4mm inlet and outlet; bigger engines have a 6mm inlet and 4mm outlet.

**Bubble-Traps** A bubble-trap type hopper tank system is highly recommended and available in the Xicoy web Shop. The bubble-trap outlet feeds direct to the inlet to the filter. If using an air trap which has a fine bag type filter (Xicoy) then the external filter CAN be omitted but beware the pump is vulnerable to particles getting in between bubble trap and pump inlet, so aim to be squeaky clean with the installation. . If desired a shut-off tap can be installed inline as a protection or where local regulations require.

The fuel outlet connects directly to the engine with 4mm piping. Do not connect anything (filters, valves, fuel meters...etc.) between the pump and the engine.

## Priming

It is strongly recommended that after a new installation or modification to the fuel system that the system be primed to clear any debris collected in the fuel line before connecting to the engine: (Note the *engine* itself *does not* require any priming)

To prime the fuel system, disconnect the fuel pipe at the engine and route it into a suitable container. Set the throttle and trim to low and proceed to the Pump Prime option in the INFO menu.

Run the fuel pump for a few seconds and be ready to hit the off button. Note the ECU battery must be connected to do this. This will help clear any air and particles that could have entered the fuel system during installation.

Don't do the prime directly into the engine as it could sweep any bits from the fuel system straight into the engine, always prime into a jar or outboard for a few seconds.



## ECU Display

There are two display options with the "X" Series engine, depending on which package you select. One (top right) is a very small black and white small screen integrated onto the Hub and housed in a plastic box, called the Compact. This is internally electrically connected to the connector board so requires no additional lead, but cannot be removed from the plane.

The other (shown below right) is a separate multicolour high resolution display mounted in a small case with a servo type lead coming out. This can be plugged into the Hub as required or can be connected and mounted permanently in the plane.



Both displays include dedicated screens for engine operation, radio checking, last shutdown cause and other special turbine operations.

## ECU data record / playback

*(Note, this function requires the colour display to be mounted permanently in the model)*

A most innovative and useful function is the internal recorder/playback function. The multicolour high resolution display continuously stores all the data received from the ECU, keeping in its permanent memory all the data of last 66 minutes of engine run.

After the flight the display can be removed from the plane and be powered up with a receiver type battery and the data stored can be played back in real time, same presentation as if the engine was running. Playback mode can be still, forward or reverse, speed x1, x 10 and x100 in both directions, so that would be easy to view the engine operation or investigate any issue at the field without the need of a computer or any other type of reader.

All the data, including all engine parameters, can also be saved later to a memory card, where it can be read using a text editor, or our viewer software. Also this data can be sent to Xicoy to be studied.

## Plug-in backlit display

### Display Screens available on the Plug-in backlit colour display:

#### Initial Screen

Initial screen with Xicoy logo.  
 Button Tools, to visualize menu.  
 Button HDT, to visualize fadece data.



#### HDT Screen

Button Back , to go initial screen.  
 Data from FADEC.  
 Buttons to navigate through FADEC menus.



#### Tools Screen

ButtonBack , to go initial screen.  
 Button Player to go Player.  
 Radio Check to go Radio Check.  
 Button Last Shutdown to go Last Shutdown.  
 Button File to go File.



#### Player Screen

ButtonBack , to go initial screen.  
 Button Play Last Run to visualize last run.  
 Button Play From to visualize stored data.



#### Radio Screen

ButtonBack , to go initial screen.  
 Radio Check Screen to visualize the set points: Full Power, Stop & Idle.



#### Last Shutdown Screen

ButtonBack , to go initial screen.  
 Last Shutdown screen to visualize the last shutdown cause, RPM, Temperature and pump on shutdown.



#### File Screen

ButtonBack , to go initial screen.  
 Button Save Data to export the data to uSD.  
 Button Update to update the firmware of the display.



The function of the buttons is described next.

## Navigating Menu Screens

The screen display is straight forward to navigate once you get the hang of it. We use the backlit display but the Compact Hub display is very similar, just follow the buttons.



Start by plugging in the display to see the open screen.

Note there are four buttons underneath the dials, < > - +.

Navigate through menus by following the prompts on the screen and pressing the button beneath the prompt.



Press the > button, 2<sup>nd</sup> in from left.

You will then see a screen showing 4 items:  
 the radio signal (Pulse 0 xxxx uS),  
 the throttle stick percent (x %),  
 the battery voltage (vb=x.x V)  
 and the current draw (Ib x.x A)

"x" = any number



Press the > button again.

You now see the four main menu root choices:

### Start Info Radio Run

Press the button beneath the START label



You now enter the stream which covers the starting functions.

Press the > button to enter.



You now see the fuel choice option.

Your choice here is Kero or Diesel.

To change option press the + button, screen will toggle between Kero and Diesel. Leave it set at the fuel of your choice.  
 Press the > button to continue



Next is the setting for minimum pump speed during the start.

Only adjust this if the combustion is slow to get going.

100 is the usual default and it increments at 25 a time with + and - buttons. Too high a setting will make flames at the starting. Leave it as factory set.

Press the > button to continue



Now we come to Glow Plug Power. It should be set as low as possible to still function. *Default is 5.8 / 6.2v*

Already adjusted and tested at factory. Only adjust this +/- if the glowplug is not able to ignite the fuel.

This could be seen by a hissing sound at the start and white smoke from exhaust. In this case, adjust upwards by 0.2v Having too high a setting shortens the life of the glowplug.



There are no more functions to adjust in this branch so exit by pressing > until you return to the opening screen.

Press the > button twice to get back to the main navigation Menu.

Press the button under the INFO option



Timer screen.

TimerServ shows the runtime on the engine since last maintenance service. Last shows the duration of the last run in secs, and (Cy) the total number of times the engine has reached idle on a start.



RX Errors screen

This shows any time when the receiver signal has been lost or outside the normal range, glitches etc, during the last run.

Normally shows 0 or low number. Is reset each new start.





Total time counter.

This screen shows the total runtime in hours of the engine since new.

It also shows engine serial number and software version.



Test starter screen.

This screen is used to test the action of the starter by pressing the button under the "On". Note the ECU should be in stick-down, trim down position. If engine has just completed a cooldown the ECU needs to be reset to re-enable this function.

Use sparingly as it can cook the starter motor and electronics.



Test Glow-plug screen.

Use this function to check the glowplug operation by pressing button under the "On". Use only briefly, you can normally hear a small squeek when activated and a hissing sound from inside the engine.

Beware sometimes a "woomf" of small flame can appear at the exhaust if any residual fuel left. Again, use only a few seconds.



Test/Prime Pump screen.

Use this function to fill the fuel line on a new installation of after the feed pipe has emptied. Disconnect from engine and prime into a rag to clear any particles, and then connect.





Do not prime into the engine, it is not needed and can make a flame on start-up.



Test Gas Valve.

We don't use gas any more but this screen refers to the valve supplying the ceramic kero burner used to start the engine.

The only test you can do is press the button beneath the "On" and you hear a click from the front of the engine, to signal all is ok. Is a rarely used function.

	<p>Test Fuel Valve.</p> <p>This test refers to the valve supplying the main fuel supply to the combustion chamber of the engine. The only test you can do is press the button beneath the "On" and you hear a click from the front of the engine, to signal all is ok. Is a rarely used function.</p>
	<p>Return now to the main navigation menu and choose RADIO</p> <p>You have a choice now to enter the menu for setting up the transmitter, or proceeding to other options.</p> <p>The transmitter setup is show in the relevant section in detail, so now choose the "No" option.</p>
	<p>THRUST CURVE. You now get to the setting for thrust curve (as indicated in the chart).</p> <p>You have three choices: Linear Half Expo Full Expo Choose the one you prefer after tests.</p>
	<p>The last item in the Radio menu options is Restart.</p> <p>Use the +/- buttons to toggle. <i>Default is OFF.</i></p> <p>You can select Off, Manual or Automatic</p> <p><b><u><i>Read the section on Restart carefully before enabling this function.</i></u></b></p>
	<p>Return now to the main navigation menu and choose RUN</p>



#### RUN Menu.

This menu is used to access all adjustable settings used for when the engine is running.



#### Full Power Screen.

This shows the maximum power setting corresponding to full throttle to the engine in Newtons and Lbs (L). (X90 shown)

You can use the buttons to derate the engine maximum power. The display shows the new maximum RPM setting together with the new maximum power.



#### Idle Speed screen.

This is pre-set at Auto, the actual speed dependent on the engine, which allows the ECU to modify the setting in response to atmospheric conditions. (X45 shown)

In hot or conditions of high altitude or low air pressure the ECU will raise this value.

You can see any change the ECU has made by checking this screen.



#### Ambient Acceleration.

This is a setting which decides the rate of acceleration of the engine. Default is Auto. ECU decides optimum for current conditions.

In case of acceleration problems, the setting can be switched to manual pre-set of Cold, Mild, Warm or Hot. Each is a slightly longer acceleration ramp.

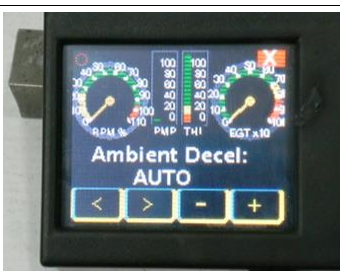

#### Ambient Deceleration.

This is a setting which decides the rate of deceleration of the engine. *Default is Auto.* ECU decides optimum for current conditions.

In case of deceleration problems, the setting can be switched to manual pre-set of Cold, Mild, Warm or Hot. Each is a slightly longer deceleration ramp.

## **Engine Installation: Electrical connections**

The "X" Series engines are very simple to install but main thing to be very careful of is any cable or battery connector which is not standard or has been modified in some way, as this can risk reverse connection of power supply which will easily destroy ECU and other components, so please be extra vigilant before using junkbox cables and/or adapters.

It's always best to use those supplied in the engine package which have been used in setting the engine up for its factory tests.

***Please don't give in to temptation.*** If you don't have the recommended type battery, please obtain one of the recommended types. Do not risk ruining your engine by trying to get it going by using a mains type power supply. Such a power supply needs to be very smooth (regulated) and capable of very high peak current at the exact recommended output voltage and such units are rare. A battery charger or similar will almost certainly be unregulated and have high voltage peaks which will destroy the components of the engine, and such use invalidates your warranty.

Just order yourself a good, high quality battery of the recommended type and use the wait for it to arrive by checking through your installation and these notes.

When it does arrive **please double check the polarity of the connector supplied before plugging in.**

***A reverse polarity battery connection WILL destroy the ECU, Pump and engine components.***

***The very briefest of puffs of smoke is all the notice you will get you have expensively killed the ECU***

### ***Shared ECU battery***

With small and light installations there may be the temptation to dispense with the receiver battery and run the receiver using a regulator from the ECU battery.

This is an absolute No-No, strongly discouraged and is surely an incident/accident waiting to happen sooner than later.

The receiver needs to be able to power many servos at once and its supply voltage will vary considerably as the servos are driven. It would be so easy for the varying supply to subsequently cause what is known as a "brown-out", a short dip in supply voltage that causes the ECU to suspend operation or reset itself.

In either case it will shut off the engine, which is very bad news so please don't do sharing the battery, keep receiver and ECU powered securely and separately.

## ECU setup

The ECU is contained on the engine. All the operating parameters relating to the starting and running of the engine are contained in its memory. All communications with the outside world occurs through the cable connected to the external Hub unit. The signal from the user's radio receiver throttle channel is used to initiate and control all functions relating to engine operation.

Interaction with the ECU and modifying or adjusting of any parameter or setting is done via buttons on a display unit plugged into the Hub or as part of the Hub with the Compact Hub option.

The ECU on the engine and all its components have been carefully programmed and tested together at the factory. They are then subject to rigorously testing together to ensure they all operate as expected so there is very little for the user to do to get the engine operational beyond the installation process and align the transmitter to the ECU and pre-set any reduced power option.

Once the engine is correctly installed and the components of the fuel system are fitted and connected up, the ECU can be aligned to the radio system. This is a simple procedure which should be done whenever your radio is programmed for a model, or the engine is new or returned from service or repair.

## Radio Setup

Confirm you have connected the ECU signal input to the throttle channel on your receiver. Connect the display to the Hub if using the "Lite" option. To navigate through the menus the two left buttons move up and down the menus, the two right buttons increase and decrease the value set. There is no need to confirm any settings unless prompted, as changing a value automatically updates it.

Connect the ECU battery and note the display screen illuminates. Remove all rates, mixes, and throttle travel settings in the transmitter. Before doing any adjustment on the ECU, check that your transmitter is sending the correct signal by checking the reading on the display.

Press the 2<sup>nd</sup> button from left once to show an information screen. Note at the top left there is a number showing the received radio signal shown as "Pulse = xxxuS". It should be between 900-1050uS at STOP position, between 1150 and 1300uS at IDLE position and between 1800 and 2200uS at Full Power position. Ignore the % reading to the top right for the moment. Please note that these readings are measured directly from the signal received from your RC system, so you should readjust your transmitter if the values read are outside that the ones suggested.



On some Futaba transmitters, it has been found that the throttle channel the sense of movement may require reversing (servo reverse) and to repeat the transmitter alignment. The setting up assumes the use of a transmitter (TX) with manual trims.

**If you use a TX with digital trims, is essential to use the switch in the TX programmed for the function "Throttle cut", or "engine cut" which normally has the effect of pro-**

**ducing the "trim-down" function. Using a digital trim cause unstable idle, and delay in shutting off the engine in emergency.**

Check your radio manual for this before you start. Avoid using the digital trim if at all possible.

Do not use a spring loaded "Throttle Cut" switch as it will prevent the engine carrying out the cooldown function. It must be a switch that stays in the position it is moved.

### ***Aligning transmitter with ECU***

As the display does not photograph well we have reproduced the display readings as a green box. Turn on the transmitter and receiver. The opening screen should show as below. Follow the steps shown to set your radio:

The correct adjustment of the throttle adjustment on the ECU can be verified in the second screen

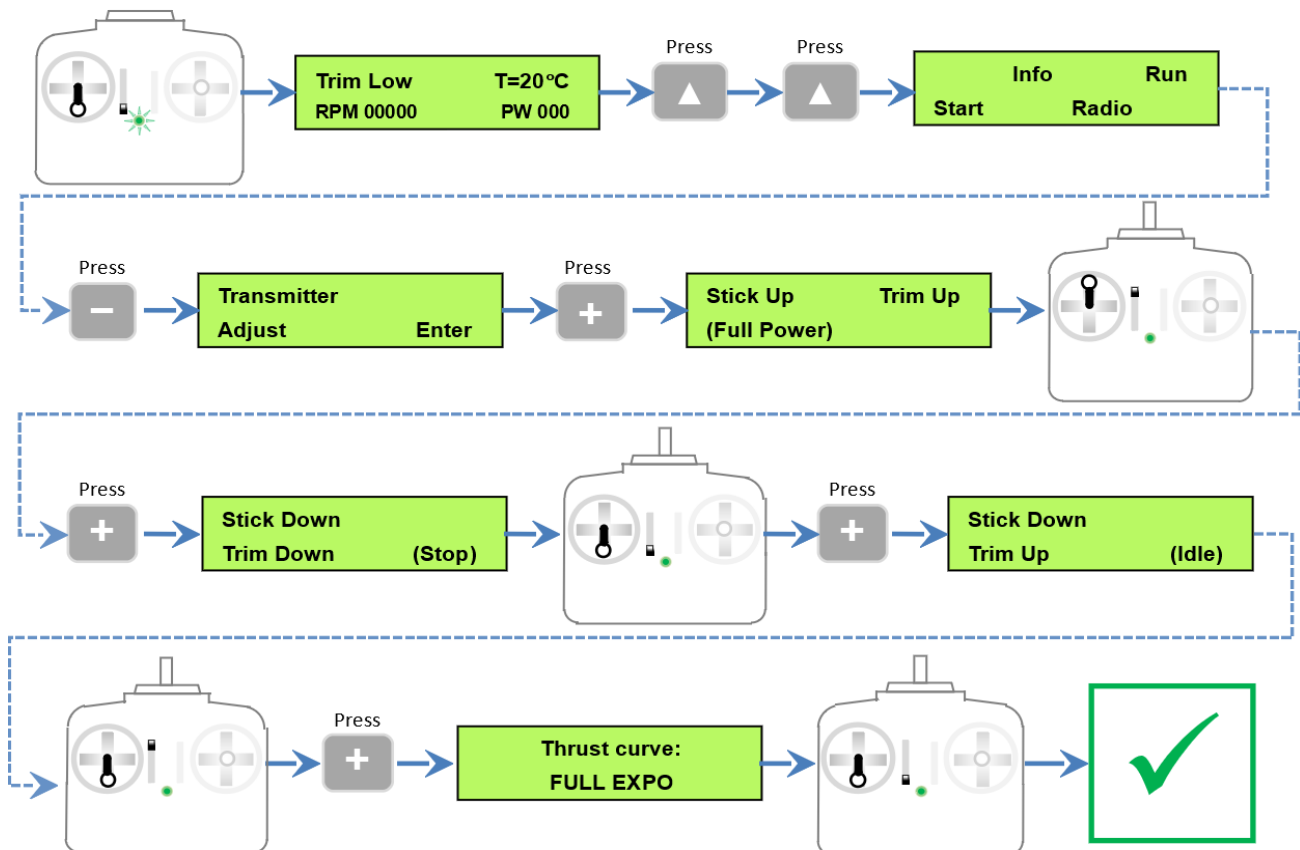

of the display as used before. The percentage of the throttle position should read 0% at the position of engine stop (trim and stick down), 100% with stick/trim full up and between 15% and 30% at idle.

We have heard problems in operation where very low trim values have been set, as the ECU struggles to differentiate between a run and stop signal.

**Make sure you programme in at least 15% travel for trim up.**

This now completes your radio setup and should only need doing again if the radio settings are changed like if you have had the engine in for service or repair.

## Failsafe

**Never fly with the failsafe set to "hold".** It is strongly recommended that you setup your radio system with the correct failsafe settings. In many countries it is mandatory that the engine stops in 2 seconds in the case of a failure of the radio link.

To program correctly the failsafe on your radio:

- 1) Adjust the travel of the throttle channel from -100% (stop position) to +100% (full power)
- 2) Adjust the ECU to your radio as described above.
- 3) Adjust the failsafe position of the throttle channel in your radio to -125%.

If all is correctly adjusted, the ECU will stop the engine immediately when receive the "STOP" signal (-100%), but if the signal received is Failsafe (-125%) the ECU will set Idle power during 2 seconds, and, if after these 2 seconds the Failsafe condition persists, will shut down the engine.

Once you have the radio programmed, check it by setting the throttle to any position, then switching off the transmitter; after two seconds the "failsafe" reading should be displayed.

There are many more parameters that can be modified in the ECU, but we have specifically programmed your ECU with the optimum settings and only made available those needed.

Further adjustment should not be required and can only be carried out by Xicoy Electronica SL or your authorized dealer or service agent.

## Preparing the engine for running

A suitable test stand should be made to hold the engine. A pair of sturdy timber rails securely fixed to a base board will suffice. Use screws to hold together, don't rely on a nailed assembly. The engine can be secured to the rails using good quality woodscrews. Use at least 20mm/3/4" long for the X45 and 25mm/1" for bigger engines, to be sure the engine is properly secure.

A platform/table/workbench is required to clamp or fix the test stand onto. Make sure this can be easily transported outside and weight enough to ensure it cannot be blown over by the thrust of the engine. Set up the fuel tank, fuel pump, battery and display onto the baseboard, ideally secured. Nothing should be fixed downstream of the engine.

Select a clear area for running – keep clear of areas with loose leaves, sand or other debris that could be picked up or drawn towards the intake. Ensure the fuel tank is position well clear of the exhaust area and secured. You and your helper and any spectators should stand at the front of the engine, not to the side.

### **Important notes for kerostart engines. PLEASE READ**

The kerostart system used on this engine is a reliable and well tested system that produces very smooth and trouble free starts. However, extra care and attention must be paid when starting a kerostart engine.

Kerosene (or diesel) is liquid and if unburned, can pool inside the engine and stay there forever. The engine can hold a big quantity of kerosene inside. This kerosene will be ignited on next successful start-up and will be pushed to the exhaust as soon as the airflow inside the engine is suffi-

cient, then it will be ignited in the exhaust, causing a hot start (in extreme cases a big fireball) that surely will not hurt the engine, but can destroy the model. So:

### ***During start-up - general***

During the start-up listen to the engine sound to check for positive sound of ignition, check looking from the exhaust that the kero is burning, or check for an increase in exhaust temperature in the display. A small plume of white smoke from the exhaust means that the fuel is not burning. The fuel is pooling inside the engine. Abort immediately the start.

Double check that the engine is not flooded. An extra security measure is to place a manual valve between the fuel tank and the pump inlet, to prevent that during the process of filling the tanks or during storage, some fuel can arrive to the engine.

After a failed start, or whatever condition that could cause that fuel be collected inside the engine (ie accidental priming), ALWAYS empty the engine of fuel by tilting the engine nose down. Fuel will exit through intake. Do not tilt upwards; as due at the internal engine construction the fuel cannot exit out through the exhaust.

Kerosene can keep burning slowly for a long time inside the engine following an aborted start, if the start-up sequence is aborted by the user or automatically before the engine arrive to idle. This can cause that the kerosene inside the engine keep burning for long time, and could destroy the engine or the model, if not noticed and dealt with.

### **IF START-UP SEQUENCE IS NOT COMPLETED, CHECK FOR FLAME INSIDE THE ENGINE.**

If there is flame, then set full throttle for over 3 seconds to engage the starter and blow out the flame. USE SHORT BURSTS OF STARTER. Using the starter for long time can overheat and destroy the starter motor. In the case that the start-up procedure has been aborted due to starter failure or the engine has jammed, then it will be necessary to apply the CO2 fire extinguisher. A white smoke plume from the engine is a good indication here; mean that there is no fire inside.

### ***First engine run***

- Confirm your test stand is securely fixed to a bench or heavy table. Keep your ear defenders within easy reach and a CO2 fire extinguisher handy. VERY IMPORTANT ON KEROSTART ENGINES. Do not use a powder extinguisher, it will ruin the engine.
- Fill the fuel tank. Do not forget to filter the fuel, and to mix the oil.
- Confirm all batteries are freshly charged and connected up.
- Check there is a temperature reading on the display.
- Ensure the running area is clear of onlookers – especially the prohibited zone of a 10 metre radius 180° arc from engine centre around the rear
- Verify that the fuel tube is full of fuel and purged of all air, if not; carry out the fuel system prime sequence after initial installation as described earlier.

While priming please observe fuel line to engine very carefully and stop as soon as fuel reaches close to the engine. Best too short than risk flood the engine.

***IMPORTANT: The prime procedure should be done only to fill the fuel tube and filter in the case of a first installation or in case of disassembling of the tubes. It does not need***



***repeating. Pushing fuel directly into the engine will cause an uncontrolled fire at next startup.***

## **Starting the engine**

Set the throttle stick down and the trim up ("Idle"). Confirm that the screen shows "Ready" i.e. Ready to start! In the case that the exhaust temperature is over 100°, the ECU will power the starter to cool down the engine. Wait until the cooling sequence finish.

Move the stick to full throttle and immediately back to idle again within 2 seconds. The ECU will begin the start-up sequence as described below:

First the internal glow plug will be energized. Soon after, the starter will be powered up to have the rotor turning at slow speed .

Once the rotor is at correct speed, the fuel pump and solenoid valves will be energized. A few seconds later (depending if the fuel is already at the engine or not) the fuel will ignite and the exhaust temperature will begin to increase. The rpm and pump power will increase automatically. During this phase the display will display "IGNITION" followed by "Preheat".

When the ignition is detected, the display will change to "SwitchOver", during this phase fuel is also routed to main injectors and speed of the rotor will be progressively increased to about 8,000RPM.

Once this phase is finished, the RPM rises and the reading will change to "FUEL RAMP". In this phase the ignition system is switched off. The fuel flow and starter power will be increased automatically to increase the RPM quickly up to idle. Just before arriving to idle the ECU will automatically disconnect power to the starter. When the rotor speed reaches idle, the screen will change to "Run IDLE" and the engine speed is adjusted to the idle RPM.

## **The engine is running!**

Control of engine power/rpm is now handed back to the transmitter and controlled by the position of the throttle stick.

### ***1<sup>st</sup> Run?***

For the 1<sup>st</sup> run following a new installation, or after refitting the engine from service or swapping from another model, start the engine and increase the throttle slowly and deliberately over a period of about 15 seconds to maximum, then wait until any "pump calibration" message clears on the display. Then decrease the throttle slowly over a period of about 10 seconds smoothly down to idle. You can then exercise the throttle with smooth operations verifying that the engine accelerates/decelerates following the throttle command. This procedure is also recommended for the 1<sup>st</sup> flight of the day after any period of layoff. You only need do it once at the beginning of the season; the ECU will remember what it was doing after that.

Take special care around the engine intake; keep your hands at a safe distance along with any objects as they can be easily ingested.

## ***Adjusting the engine maximum power.***

The engine comes from factory adjusted for its maximum thrust. But it is possible to reduce the maximum power if necessary. To do so, go to RUN menu and scroll the menus up to "Max RPM". Using the + and – buttons, you can change the engine speed at full throttle. Beside the full power RPM, the equivalent thrust in Newton and in Lb. Please note that these figures are calculated based on an ambient temperature of 15°C at sea level. Hotter ambient/higher altitude will reduce the power output. You can make the adjustment while the engine is running to see the effect but be aware the new setting will take a little time to settle.

## **Engine shut down procedure**

To shut down the engine lower the trim and the stick. It is recommendable that before shutting down the engine to restrain the model and then raise the throttle stick to approximately 25%, allowing temperatures to stabilize for around 5 seconds before carrying out the shutdown procedure. After the shutdown the ECU will keep the starting motor running to cool the engine under 100°C. A special feature on this system is that the power of the receiver can be switched off before the cooling procedure is complete. The ECU will shut down itself when the procedure is complete.

## **WHAT TO DO IN THE CASE OF AN EMERGENCY**

During the start sequence the ECU will be in charge of everything, controlling temperature and RPM. The only thing the user can do is to abort the sequence by lowering the trim in the case that something abnormal (excessive flames in the exhaust, grinding noise, etc).

If a problem is detected, first: Move the trim to the low position to abort the sequence. If there is a fire in the engine and the problem is because the starter has failed or the engine is seized (not turning), **IMMEDIATELY APPLY THE FIRE EXTINGUISHER** through the intake side of the engine, never through the exhaust.

If there is a fire, but the engine rotor remains free to spin and the starter is OK, raise the stick to the full power position for 3 seconds, this will connect the starter manually to ventilate the engine and extinguish the fire. The throttle channel acts as a starter switch. Be sure to lower the trim with the stick to avoid triggering another start.

## **Autorestart function**

All X Series engines include the AUTORESTART function. This function can quickly restart an engine automatically, but it should be understood that such a system may cause damage to people and property if triggered inappropriately. By default this function is disabled in the ECU, the user should expressly enable it. By enabling this function, the user agrees that he have understood the working principles and understands its limitations.

### **Restart options and how to enable them:**

Within the "Radio" menu, a selection defines the restart operation. The ECU offers 3 choices:

- **Standard operation (off):** After the shutdown the ECU should be reset (power cycled off then on) to enable another start-up cycle. Engines are supplied in this mode from factory.



- **Manual restart:** User can normally shutdown the ECU through the transmitter (by lowering the stick and trim). The ECU will execute the normal shutdown and post run cooling cycle. Once the cooling is finished (temperature below 100°C), the ECU will return to power-up state allowing the engine to be restarted through the normal procedure (Trim-up, cycle stick). The time to shut down and later start is exactly the same as standard operation. This mode is useful for gliders, where the engine is used to climb to height, shutdown, soaring, restart, climb, etc. This mode does not pose any safety hazard besides the fact that the engine can be started inadvertently if the start procedure is executed in the transmitter after the flight.

- **Autorestart:** In particular case of a fuel bubble that momentarily stops the combustion, the ECU will detect this condition by monitoring the rpm, temperature and pump power, and then the ECU triggers the auto-restart sequence. This sequence is done with the engine hot, so the power is restored quickly. This restarting function can help save the plane in few limited circumstances.

**But it can also greatly increase the risk of fire, so before to enable this function, please read and understand the following:**

#### **What does the auto-restart function does:**

It automatically tries to restart the engine quickly and restore the power setting that is being asked by the transmitter. To trigger this function, the ECU checks:

- The radio signal is valid, no failsafe condition.
- The readings of the RPM are consistent with a flameout condition (the speed of the RPM coasting down is between preset limits).
- The readings of the exhaust temperature are consistent with a flameout condition.
- The battery voltage is good.
- No other faults detected.

Once the ECU is satisfied that the shutdown/flameout was most likely caused by an interruption of combustion, usually caused by an air bubble, the ECU triggers the quick restart function, where the ignitor is energized to full voltage and the pump is started at a power dependent of the current engine status (RPM and EGT). Once the ECU detects that the combustion has reassumed, the starter power is set to full power to reach the idle rpm as quickly as possible, and the pump power is increased accordingly to the real RPM increase, allowing for delays caused by bubbles arriving to the engine. If after 10 seconds of restart the ECU doesn't detect a stable combustion, the procedure is aborted and the normal cooldown initiated.

#### **What the Autorestart function will not do:**

- It will not restart the engine if the shutdown was caused by any fault other than a typical flame out caused by air in the fuel system.
- It will not monitor and confirm flight conditions are optimum for a restart. Leaving the restart to progress is the pilot responsibility and decision, depending on each particular case.

#### **When should Autorestart function be enabled?**

Auto-restart is fast but still takes an average time of 10s-15s to establish restored level of pre-shutdown power. It is highly recommended that Auto-restart only be used on airframes capable of

sustaining enough flight for the re-start to be completed. Some aircraft examples include: lightly loaded planes, gliders, or multi engine planes.

It is highly advised that a shutdown simulation be done before selecting Auto-restart option in the ECU RADIO menu. Do it during a normal flight at a high altitude, then throttle down to idle then begin a 15sec count down. From this try to gauge if the aircraft can maintain controlled flight during this time at idle setting.

*If your plane cannot maintain flight for a minimum of 10sec without engine power, do not enable the Auto restart function.*

**"I'm flying my plane and the engine has shutdown with restart enabled, what should I do":**

1. **Think that the chances of that the engine restart are slim.** You don't know why it has shut down, so likely it will not restart, DO NOT RELY on it.
2. **Fly your plane.** Leave the throttle at mid setting and fly your plane keeping airspeed in aft for a dead stick landing.
3. **In case you see the plane begins to stall** or an uncontrolled landing is most likely, **IMMEDIATELY set the trim and stick to STOP** position to abort the restart function. A crash with the engine running normally ends with a fireball; a crash with the engine off is not likely to catch fire.

*Do not use the "digital trims" to shut down the engine, use a dedicated switch to be operated quickly.*

4. **If the engine restart is initiated while on approach,** evaluate if the speed/position of the plane is still good for a safe landing, if so, land immediately, you don't know why the engine stopped and may stop again during a "go around" but this time the aircraft may not be in an as favourable position. If the position/speed of the plane is not convenient, use the engine power to go around and plan for a normal landing, BUT land as soon as possible.
5. **Once the plane is on the ground,** even in normal landing or crash landing, set the transmitter in the STOP position. The engine could restart and go to full power on its own; the ECU does not know when the plane is on the ground.

**"Can I use the restart function many times"?**

**NO!**

**Restart function is an emergency procedure** and places a high stress on the engine ancillary components. The starter and ignitor are fed with extra power that is not used in normal startups, this places considerable more wear on them, also the engine is subjected to abrupt temperature changes that could shorten its life.

**Restart function is not the replacement of a poor fuel system.** It can save a plane in particular circumstances, but it can do much more harm than good. A belly landing or landing gear damage due to a flameout induced heavy landing is more favourable than a similar landing arrival with the engine in start phase that can possibly cause a fire and result in total destruction of the model and or property.

Please consider carefully before enabling the auto-restart feature.

**Restart Disclaimer**

*There are no circumstances Xicoy Electronica SL or any of its Service Agents and employees will accept or be held responsible for any losses or damages the Auto Restart feature causes should the owner operator choose to enable this function.*

**Throttle curves**

The ECU controls the RPM in linear way, i.e., at half stick position the engine turn at half of the rotor RPM range. However, jet engines develop thrust in exponential way, meaning half RPM means approximately 1/4 of thrust.

On small engines with a high idle to full power rpm ratio, or in a high drag/low power planes, often only the last 1/3 of the throttle stick produce significant thrust, with the low half stick travel being not much used. Although with current digital TX the pilot can modify the throttle curve to suit needs, three throttle curves have been added to simplify the setup for most of the installations.

These curves are selected under the RADIO menu:

**FULL EXPO:** Means thrust is linear to RPM, it is the default setting. Thrust develops exponentially, and it is the recommended curve for high thrust/weight ratio planes, as it ease the control in low power used during taxi.

**LINEAR:** Mean that the thrust develop linearly with the throttle setting. Could cause difficult taxi, as it would be difficult to fine adjust the power at low setting.

**HALF EXPO:** An intermediate setting between the other two modes



**Throttle stick position chart**

		Stick Position				
MODE	0% (Idle)	25%	50%	75%	100%	
<b>FULL EX-PO</b>	Idle thrust	6%	25%	56%	100%	<b>% of total thrust</b>
<b>HALF EX-PO</b>	Idle thrust	16%	38%	66%	100%	
<b>LINEAR</b>	Idle thrust	25%	50%	75%	100%	

Throttle curves can be changed while the engine is running, so you can leave the throttle at a given position and switch between the curves to see the difference.

**Acceleration and deceleration settings.**

In the "RUN" menu it is possible to change the acceleration and deceleration times. The engine is supplied and tested from factory ready to use and usually these settings should be correct for

normal use. However the user can modify these default settings to allow the engine to run optimally in different conditions.

The usual acceleration setting are set to AUTO which gives the engine a good response but tries to minimise the risk of over-fuelling in a sudden acceleration. In AUTO mode, the ECU adjusts itself for optimum running at the current ambient conditions reported by the sensors built into the Hub, and in extreme cases it also raises the idle speed accordingly.

Leave the acceleration and deceleration in "Auto" mode when using the engine with kerosene and at ambient temperatures below 25°C and elevation below 500m. If diesel fuel is used, or ambient temperature is over 25°C or altitude is over 500m, then the engine *perhaps* experience difficulties in accelerating. In these cases, try setting the acceleration to "mild", "warm" or "hot" to find a setting where the engine operates normally, "Cold" is the fastest acceleration and "very hot" being the slowest. You can make the selection while the engine is running to quickly see changes. It is much better to have an engine respond slightly slower to throttle changes than one that just stop when asked to accelerate faster than possible in difficult ambient conditions.

### **Exhaust tubes.**

The size and placement of the exhaust tube is not an exact science. The optimum tube diameter and the gap between the engine exhaust and the tube intake is largely dependent of the airframe. An slow airframe with big intakes will benefit of larger exhaust diameter and larger gap, to get the maximum static thrust possible, while a fast airframe, with small intakes, bypass installation, will benefit of smaller exhaust diameter and smaller gap, to get the maximum efflux speed.

Use an exhaust tube of a minimum diameter as shown on the specifications chart, with a gap between the engine exhaust and beginning of exhaust tube (excluding the bell mouth) of 25mm (1"). Later you can experiment moving the engine 5mm (0.2") forward or aft to see if performance is better. Too larger gap will cause hot gases to recirculate to the engine intake, decreasing performance and worsening the acceleration. Too short gap will cause extra pipe noise and depression inside the pipe, in extreme cases the exhaust tube can collapse due the low pressure inside (venturi effect).

### **Use in gliders and in 3D planes.**

If you plan to use your engine in a glider, please consider to de-rate your engine. The typical large glider use that is running at full power continuously for the entire flight in airframes that easily weight 4 times the engine thrust is very hard for the engine, as the internal elements like combustion chamber are subjected to maximum temperature and stress all the time, reducing the time between overhauls. We would recommend using the engine at 80% of its maximum power in these conditions, or using the 100% for take-off, but later reducing to 80% during continuous climb.

We don't recommend using our engines in 3D planes doing fast acrobatics. The gyroscopic forces that a turbine rotor turning at very high RPM's apply to the bearings doing a loop in less than 1s are extremely high and can destroy the bearings or cause the compressor or turbine wheels to rub to the engine case.

### **List of ECU message codes**

Here is a list of possible messages shown on the data terminal screen and their meaning.

1. **TrimLow:** Indicates that the signal received from the transmitter corresponds to the lowered trim, that is to say, engine OFF.
2. **Ready:** Indicates that the engine is ready for starting, and that the transmitter signal corresponds to IDLE.
3. **StickLo!:** This indicates that the throttle stick is in a position above IDLE, the engine will not start with the stick in this position.
4. **Glow Test:** Verification of glow plug
5. **StartOn:** Test of the starter and rpm sensor
6. **Ignition:** Ignition phase.
7. **SwitchOver:** Phase of heating of the combustion chamber after detecting the ignition.
8. **FuelRamp:** Phase of acceleration until idle speed.
9. **Run Idle:** Engine working correctly, pilot have full control of engine power, command received from transmitter is IDLE.
10. **Running:** Engine working correctly, pilot have full control of engine power, command received is an intermediate setting between Idle and Full Power.
11. **Run-Max:** Engine working correctly, pilot have full control of engine power, command received is Full Power
12. **Cal-Pump:** Pump is being calibrated, usually at full rpms. Hold throttle steady a few seconds until it is finished.
13. **Stop:** Engine off.
14. **Cooling:** Starter is operating to cool the engine.
15. **GlowBad:** Defective or disconnected glow plug.
16. **StartBad:** Insufficient RPM reached during start, RPM sensor damaged, too thick oil used on previous run causing excessive bearing drag, no cooling sequence done in previous run, no rpm signal, defective starter.
17. **Low RPM:** Engine had been shut down because the speed has fallen below the minimum. Usually lack of fuel (bubble)
18. **HighTemp:** Excessive temperature.
19. **Battery!:** battery voltage out of limits.
20. **Pump Overload:** There is a restriction in the fuel path from the pump to the engine, or in the engine itself, possibly the fuel valve partially closed or semi blocked.
21. **No Data:** Means that the data terminal is not receiving any data from the engine. Usual causes are battery disconnected, Data Terminal in wrong port, throttle lead connected in wrong port, pump lead reversed

### **Diagnoses:**

In order to access these measures, it is necessary to shut down and power-up the ECU. Set the trim down (trimLow) and push the left button on the display. The ECU will show the cause of last shutdown and the parameters value at the moment of shut down.

These are as follows:

### ***Diagnosis messages:***

1. **UserOff:** The engine has been shut down because it has received the shutdown command from the transmitter.
2. **FailSafe:** The engine has been shut down because of loss of the control signal from the transmitter. After 0,5s of detecting a loss or invalid RC signal, the ECU sets engine power to idle, and if after another 1,5seconds a valid signal is still not received the engine is shut down.
3. **LowRPM:** The engine has been shut down because the RPM has dropped below a minimum. Cause could be lack of fuel, air bubbles, problem with the batteries, or defective RPM sensor.
4. **RCPwFail:** Lack of power from the radio receiver.

### **Telemetry:**

Xicoy Electronica offers several additional modules that allow transmitting the engine data in real time to an external receiver.

Using the TeleSpek module is possible to connect only to Spektrum radios using the TM1000 module.

Using the Flight Computer device is possible to connect to the following RC equipment: Jeti, Futaba, Multiplex, HoTT, FrSky, and PB Core.

Using the TelemetryX module is possible to connect to the following RC equipment: Jeti, Futaba, Multiplex, HoTT, FrSky and PB Core.

If you purchase the TelemetryX module, it will be necessary to configure it to your radio brand. Follow the instructions of the module, except if you purchased the Compact version. In this case, to access to the telemetry module menus, you should disconnect the cable to the engine, and power-up the system while holding pressed the first button on the left on the display module.

### **Tank capacity adjustment:**

If the ecu has software version 8.13 or higher **AND** the telemetry adapter module was manufactured on or after October 2021, then the tank capacity setting for telemetry purposes is set in the ecu.

For previous versions of ecus OR telemetry adapters, the capacity of the tank is adjusted in the telemetry module, follow its instructions.

If the ecu has software version 8.13 or higher, and it detects that is connected to a compatible telemetry module, then it will show two new settings in the "RUN" menu.

**Fuel Capacity:** Use the +/- buttons to adjust the capacity of the tank.

**Fuel calibration:** use the +/- buttons to fine tune fuel consumption. The ecu knows the pump that is operating and leaving the calibration at 0% should give a fairly correct measure, but with this adjustment it is possible to make a fine adjustment of the consumption measurement to compensate for differences between fuel systems (tanks in series, filters restrictive, long tubes...) that may require the pump to work harder than the nominal.